

PRODUCT SPECIFICATION

COSMO ELECTRONICS CO., LTD.	Photocoupler : K1010	SHEET 1 OF 5
---------------------------------------	--------------------------------	--------------

High Reliability Photocoupler

● Features

1. Current transfer ratio
(CTR : MIN. 60% at $I_F=5\text{mA}$ $V_{ce}=5\text{V}$)
2. High isolation voltage between input and output (Viso : 5000Vrms).
3. Compact dual-in-line package.

● Applications

1. Registers, copiers, automatic vending machines.
2. System appliances, measuring instruments.
3. Computer terminals, programmable controllers.
4. Communications, telephone, etc.
5. Electric home appliances, such as oil fan heaters, Microwave oven, Washer, Refrigerator, Air conditioner, etc.
6. Medical instruments, physical and chemical equipment.
7. Signal transmission between circuits of different potentials and impedances.
8. Facsimile equipment, Audio, Video.
9. Switching power supply, Laser beam printer.

PRODUCT SPECIFICATION

COSMO ELECTRONICS CO., LTD.	Photocoupler : K1010	SHEET 2 OF 5
---------------------------------------	--------------------------------	--------------

1. OUTSIDE DIMENSION : UNIT (mm)

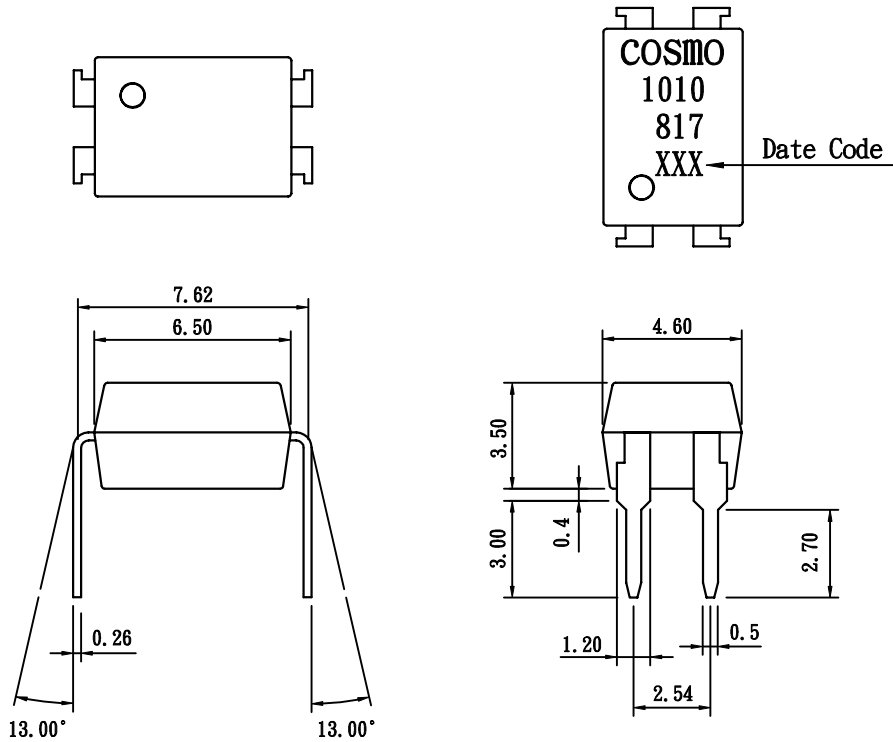

TOLERANCE : $\pm 0.2\text{mm}$

2. SCHEMATIC : TOP VIEW

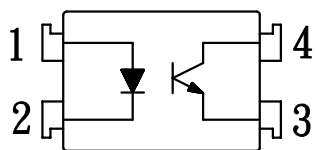

1. Anode
2. Cathode
3. Emitter
4. Collector

PRODUCT SPECIFICATION

COSMO ELECTRONICS CO., LTD.	Photocoupler : K1010	SHEET 3 OF 5
---------------------------------------	--------------------------------	--------------

• Absolute Maximum Ratings

(Ta=25°C)

Parameter		Symbol	Rating	Unit
Input	Forward current	I _F	50	mA
	Peak forward current	I _{FM}	1	A
	Reverse voltage	V _R	6	V
	Power dissipation	P _D	70	mW
Output	Collector-emitter voltage	V _{CEO}	60	V
	Emitter-collector voltage	V _{ECO}	6	V
	Collector current	I _c	50	mA
	Collector power dissipation	P _c	150	mW
Total power dissipation		P _{tot}	200	mW
Isolation voltage 1 minute		V _{iso}	5000	V _{rms}
Operating temperature		T _{opr}	-30 to +100	° C
Storage temperature		T _{stg}	-55 to +125	° C
Soldering temperature 10 second		T _{sol}	260	° C

• Electro-optical Characteristics

(Ta=25°C)

Parameter		Symbol	Conditions	MIN.	TYP.	MAX.	Unit
Input	Forward voltage	V _F	I _F = 20mA	-	1.2	1.4	V
	Peak forward voltage	V _{FM}	I _{FM} = 0.5A	-	-	3.5	V
	Reverse current	I _R	V _R = 4V	-	-	10	uA
	Terminal capacitance	C _t	V = 0, f = 1kHz	-	30	-	pF
Output	Collector dark current	I _{CEO}	V _{CE} = 20V	-	-	0.1	uA
Transfer characteristics	Current transfer ratio	CTR	I _F = 2mA, V _{CE} = 5V	60	-	600	%
	Collector-emitter saturation voltage	V _{CE(sat)}	I _F = 20mA, I _c = 1mA	-	0.1	0.3	V
	Isolation resistance	R _{iso}	DC500V	5x10 ¹⁰	10 ¹¹	-	ohm
	Floating capacitance	C _f	V = 0, f = 1MHz	-	0.6	1.0	pF
	Cut-off frequency	f _c	V _{CC} = 5V, I _c = 2mA, R _L = 100ohm	-	80	-	kHz
	Response time (Rise)	t _r	V _{CC} = 5V, I _c = 2mA, R _L = 100ohm	-	5	20	us
	Response time (Fall)	t _f		-	4	20	us

Fig. 1 Current Transfer Ratio vs. Forward Current

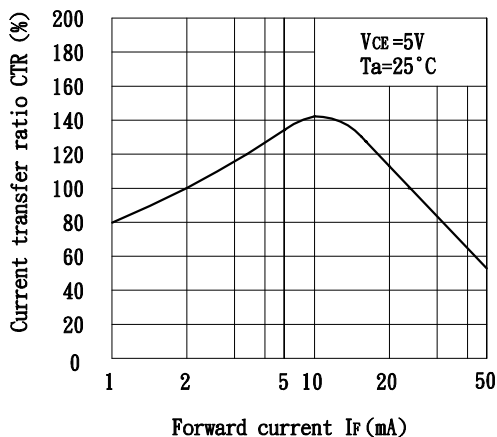

Classification table of current transfer ratio is shown below.

Model NO.	CTR (%)
K1010 A	60 TO 160
K1010 B	130 TO 260
K1010 C	200 TO 400
K1010 D	300 TO 600
K1010 E	60 TO 600

PRODUCT SPECIFICATION

<p>COSMO ELECTRONICS CO., LTD.</p>	<p>Photocoupler : K1010</p>	<p>SHEET 4 OF 5</p>
---	--	---------------------

Fig. 2 Collector Power Dissipation vs. Ambient Temperature

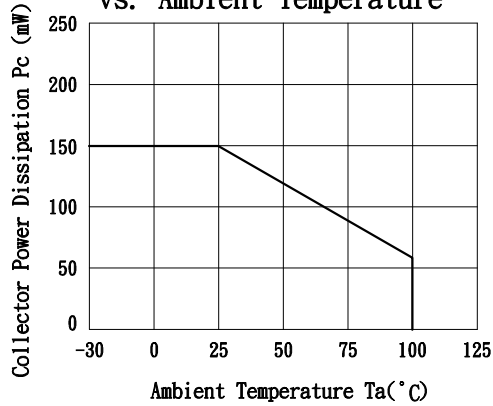

Fig. 3 Collector Dark Current vs. Ambient Temperature

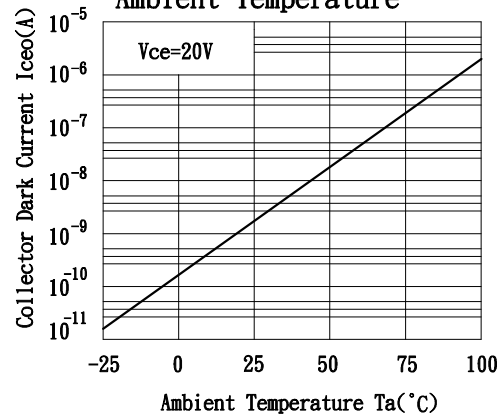

Fig. 4 Forward Current vs. Ambient Temperature

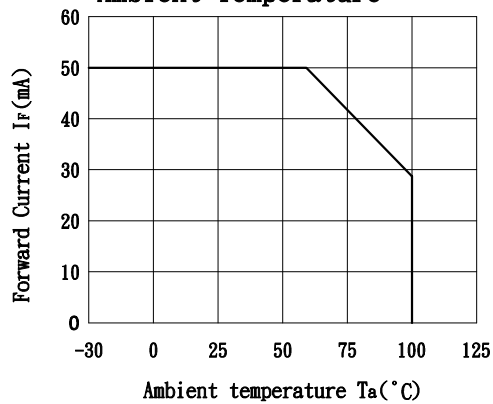

Fig. 5 Forward Current vs. Forward Voltage

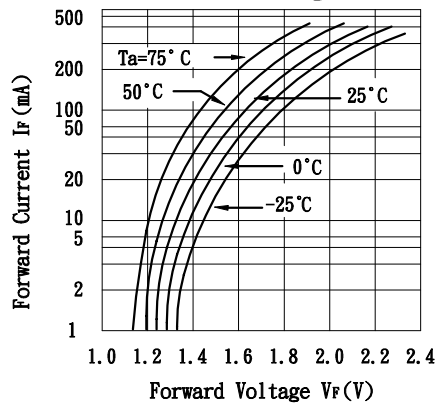

Fig. 6 Collector Current vs. Collector-emitter Voltage

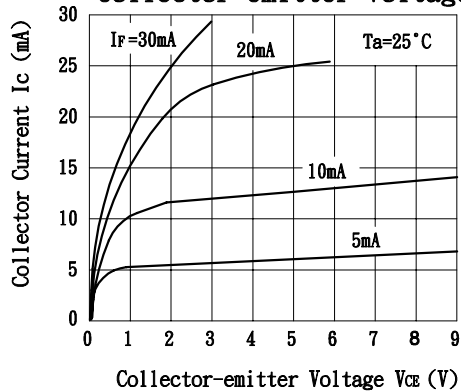
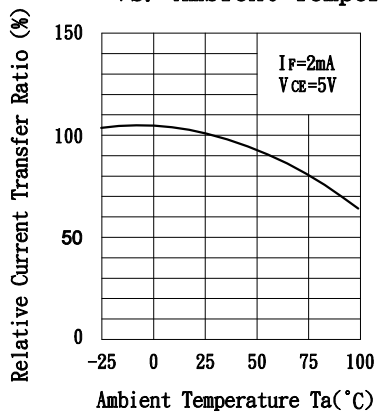

Fig. 7 Relative Current Transfer Ratio vs. Ambient Temperature



PRODUCT SPECIFICATION

COSMO ELECTRONICS CO., LTD.	Photocoupler : K1010	SHEET 5 OF 5
---------------------------------------	--------------------------------	---------------------

Fig. 8 Collector-emitter Saturation Voltage vs. Ambient Temperature

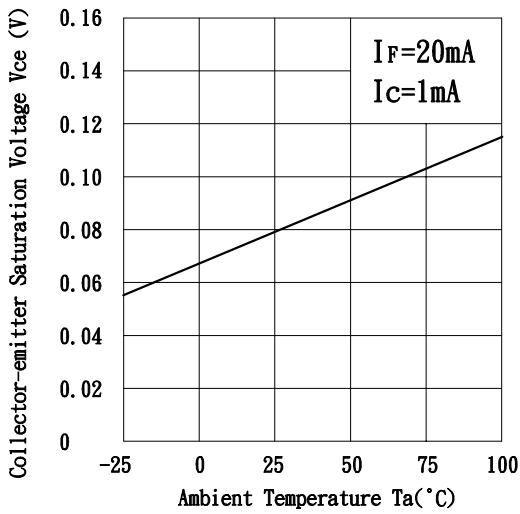

Fig. 9 Collector-emitter Saturation Voltage vs. Forward Current

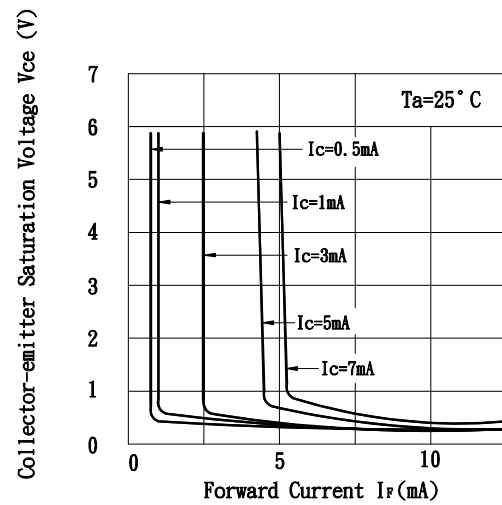

Fig. 10 Response Time vs. Load Resistance

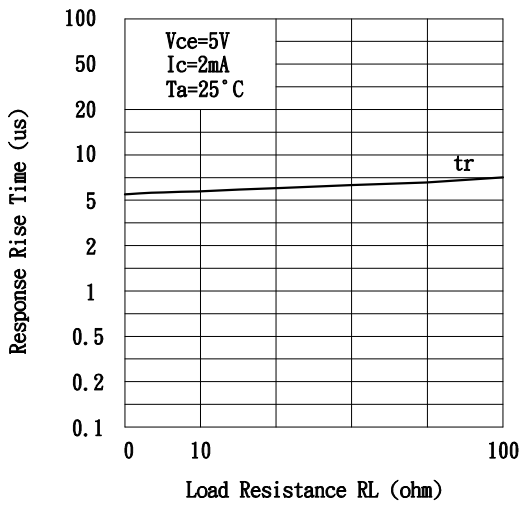

Fig. 11 Response Time vs. Load Resistance

